



# iPilot™

Owner's Manual



# TABLE OF CONTENTS

- Introduction ..... 3**
- Two-Year Warranty ..... 4-5**
- Installation..... 6-25**
  - Parts List.....6-9
  - Preparing for Installation ..... 10
  - Installation of i-Pilot Controller..... 11-27
  - Verifying Installation ..... 28-29
- Getting Started ..... 30-37**
  - Knowing Your Remote ..... 30-32
  - Knowing Your i-Pilot Controller ..... 33-36
  - System Startup ..... 37
- Manual Control..... 38-41**
- GPS Motor Control.....42-61**
  - Spot Lock ..... 44-47
  - Cruise Control..... 48-49
  - AutoPilot /Advanced AutoPilot ..... 50-55
  - Track Recording/Playback.....56-61
- Frequently Asked Questions..... 62-63**
- Troubleshooting..... 64-67**
- Glossary ..... 68-69**
- Compliance Statements ..... 70-71**
- Warranty Card ..... 72**
- Accessories ..... 73**
- Notes .....74-75**

# INTRODUCTION

## Overview

Thank you for purchasing the Minn Kota® i-Pilot®. This revolutionary control system uses GPS technology to record and store tracks and locations which are then used to deliver unprecedented levels of boat control. Intuitive features and wireless control help to accurately position your boat and improve your bait presentation. i-Pilot navigates and positions your boat for you, so you can focus on fishing.

This i-Pilot User Guide is divided into four main sections: Installation, Getting Started, Manual Control, and GPS Motor Control. A waterproof and easy-to-read Quick Reference Guide is also included as a supplement to the User Guide, both of which can be stored in the boat for easy access.

A French version of the manual is available on line at [minnkotamotors.com](http://minnkotamotors.com)

Une version français du manuel est disponible en ligne à [minnkotamotors.com](http://minnkotamotors.com)

## Safety and Cautions

You are responsible for the safe and prudent operation of your vessel. We have designed i-Pilot to be an accurate and reliable tool that will enhance boat operation and improve your ability to catch fish. This product does not relieve you from the responsibility for safe operation of your boat. You must avoid hazards to navigation and always maintain a permanent watch so you can respond to situations as they develop. You must always be prepared to regain manual control of your boat. Learn to operate your i-Pilot in an area free from hazards and obstacles.

## Warranty and Registration

To receive all the benefits of your product warranty please fill out and mail the warranty registration card. You may also register your product online at [minnkotamotors.com](http://minnkotamotors.com).

Correctly installing i-Pilot on a Minn Kota trolling motor will not void the original motor warranty or the warranty of any previously installed accessories. Installing i-Pilot will not extend the warranty of any Minn Kota product it is being installed into or in conjunction with.



## LIMITED TWO-YEAR WARRANTY ON ENTIRE PRODUCT:

Johnson Outdoors Inc. warrants to the original purchaser that the purchaser's entire i-Pilot System<sup>®</sup> accessory is free from defects in materials and workmanship appearing within two (2) years after the date of purchase. Johnson Outdoors Inc. will, at its option, either repair or replace, free of charge, any parts found to be defective during the term of this warranty. Such repair or replacement shall be the sole and exclusive liability of Johnson Outdoors Inc. and the sole and exclusive remedy of the purchaser for breach of this warranty.

These limited warranties do not apply to i-Pilot Systems used commercially, nor do they cover normal wear and tear, blemishes that do not affect the operation, or damage caused by accidents, abuse, alteration, modification, misuse or improper care or maintenance. **DAMAGE CAUSED BY THE USE OF OTHER REPLACEMENT PARTS NOT MEETING THE DESIGN SPECIFICATIONS OF THE ORIGINAL PARTS WILL NOT BE COVERED BY THIS LIMITED WARRANTY.** The cost of normal maintenance or replacement parts that are not defective are the responsibility of the purchaser.

To obtain warranty service in the U.S., the part believed to be defective and proof of original purchase (including the date of purchase) must be presented to a Minn Kota Authorized Service Center or to Minn Kota's factory service center in Mankato, MN. Any charges incurred for service calls, transportation or shipping/freight to/from the Minn Kota Authorized Service Center or factory, labor to haul out, remove, re-install or re-rig products removed for warranty service, or any other similar items are the sole and exclusive responsibility of the purchaser. i-Pilot systems purchased outside of the U.S. (or parts of such systems) must be returned prepaid with proof of purchase (including the date of purchase and serial number) to any Authorized Minn Kota Service Center in the country of purchase. Warranty service can be arranged by contacting a Minn Kota Authorized Service Center listed on the enclosed sheet or by contacting the factory at

1-800-227-6433, 1-507-345-4623 or fax 1-800-527-4464. Note: Do not return your i-Pilot or parts to your retailer. Your retailer is not authorized to repair or replace them.

THERE ARE NO EXPRESS WARRANTIES OTHER THAN THESE LIMITED WARRANTIES. IN NO EVENT SHALL ANY IMPLIED WARRANTIES, INCLUDING ANY IMPLIED WARRANTIES OF MERCHANTABILITY OR FITNESS FOR PARTICULAR PURPOSE, EXTEND BEYOND TWO YEARS FROM THE DATE OF PURCHASE. IN NO EVENT SHALL JOHNSON OUTDOORS MARINE ELECTRONICS L.L.C. BE LIABLE FOR INCIDENTAL, CONSEQUENTIAL OR SPECIAL DAMAGES.

Some states do not allow limitations on how long an implied warranty lasts or the exclusion or limitation of incidental or consequential damages, so the above limitations and/or exclusions may not apply to you. This warranty gives you specific legal rights, and you may also have other legal rights which vary from state to state.

“WARNING: This product contains chemical(s) known to the state of California to cause cancer and/or reproductive toxicity.”



# PARTS LIST VIEW TERROVA

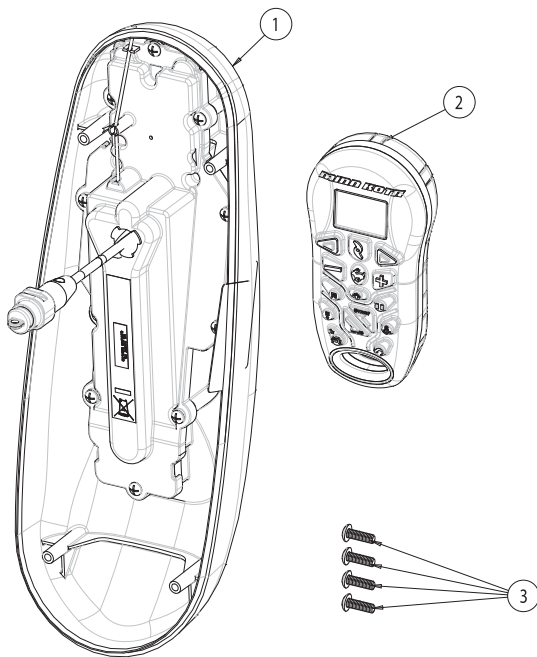

ITEM #	PART NUMBER	DESCRIPTION	QTY
1	2990255	I-PILOT CONTROLLER, TERROVA	1
2	2994085	REMOTE, ASSEMBLY I-PILOT	1
3	2372100	SCREW, #8-18 X 5/8" SS	4
4*	2377150	MANUAL, I-PILOT	1
5*	2377151	MANUAL, I-PILOT QUICK REFERENCE GUIDE	1

*\* Not Shown In Exploded View*



## PARTS LIST VIEW RIPTIDE ST

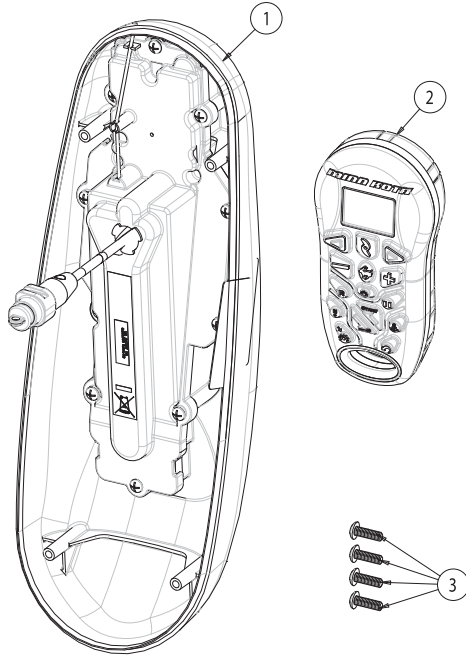

ITEM #	PART NUMBER	DESCRIPTION	QTY
1	2990256	I-PILOT CONTROLLER, RIPTIDE ST	1
2	2994085	REMOTE, ASSEMBLY I-PILOT	1
3	2372100	SCREW, #8-18 X 5/8" SS	4
4*	2377150	MANUAL, I-PILOT	1
5*	2377151	MANUAL, I-PILOT QUICK REFERENCE GUIDE	1

*\* Not Shown In Exploded View*

# PARTS LIST VIEW POWERDRIVE V2

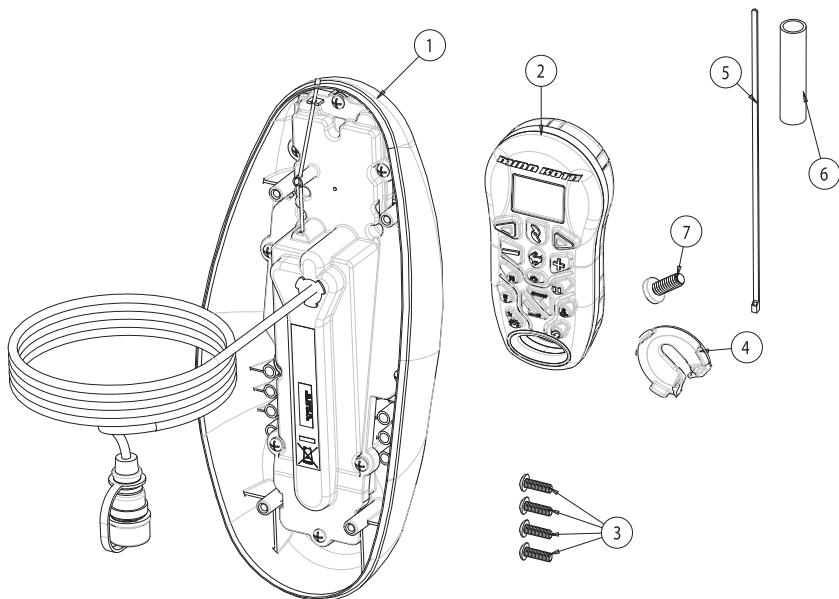

ITEM #	PART NUMBER	DESCRIPTION	QTY
1	2990265	I-PILOT CONTROLLER, POWERDRIVE V2	1
2	2994085	REMOTE, ASSEMBLY I-PILOT	1
3	2372100	SCREW, #8-18 X 5/8" SS	4
4	2224704	INSERT PLUG, BLACK SLOTTED	1
5	2376312	TIE, NYLON	5
6	2375403	HEAT SHRINK, .375 X 2 ADHESIVE LINED 3:1	4
7	2303430	SCREW - 1/4 - 20 X 5/8 - SELFTAP ZP	2
8*	2377150	MANUAL, I-PILOT	1
9*	2377151	MANUAL, I-PILOT QUICK REFERENCE GUIDE	1

*\* Not Shown In Exploded View*



# INSTALLATION



## PARTS LIST VIEW RIPTIDE SP

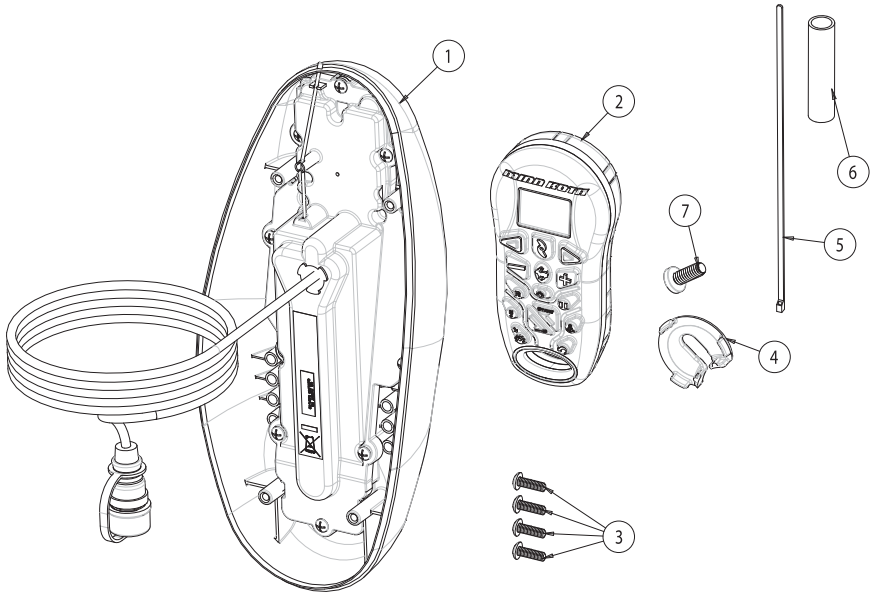

ITEM #	PART NUMBER	DESCRIPTION	QTY
1	2990266	I-PILOT CONTROLLER, RIPTIDE SP	1
2	2994085	REMOTE, ASSEMBLY I-PILOT	1
3	2372100	SCREW, #8-18 X 5/8" SS	4
4	2224705	INSERT PLUG, WHITE SLOTTED	1
5	2376312	TIE, NYLON	5
6	2375403	HEAT SHRINK, .375 X 2 ADHESIVE LINED 3:1	10
7	2332104	SCREW - 1/4 - 20 X 5/8 SS	2
8*	2377150	MANUAL, I-PILOT	1
9*	2377151	MANUAL, I-PILOT QUICK REFERENCE GUIDE	1

\* Not Shown In Exploded View

## PREPARING FOR INSTALLATION

### Preparing for Installation

Tools you will need during installation

#### **Terrova and Riptide ST**

- Phillips screwdriver

#### **PowerDrive V2**

- Phillips screwdriver
- Needle-nose pliers
- Utility knife

#### **Riptide SP**

- Phillips screwdriver
- Needle-nose pliers
- Utility knife
- Heat gun or other heat source for installing heat shrink

Before installing i-Pilot on your motor, make sure the trolling motor is properly installed on your boat. Find a clean and dry location for performing the installation.

Most importantly, disconnect all power to the trolling motor before installation. Not only will this protect you but also the sensitive electronics you are about to install.

Read through the entire installation process before performing the installation.

If you need help or need further instruction on installing i-Pilot, please go online at [minnkotamotors.com](http://minnkotamotors.com) for a full step-by-step, guided installation video. You may also call Minn Kota technical service at 1-800-227-6433 to talk to a customer service representative.



## INSTALLATION OF I-PILOT CONTROLLER

For PowerDrive V2 and Riptide SP trolling motors go to page 13.

### i-Pilot Installation on Terrova and Riptide ST Trolling Motors

*\*i-Pilot will override all **CoPilot** functionality. **CoPilot** remotes will not function with i-Pilot.*

*\*The Terrova foot pedal is fully functional and supported when i-Pilot is installed correctly.*

1. Remove all power to the trolling motor.
2. Remove control box cover screws and cover using Phillips screwdriver. (Figure 1)
3. If the trolling motor has the **AutoPilot** feature, unplug the **AutoPilot** control board and remove it from the control box. (Figures 2 and 3)



FIGURE 1



FIGURE 2



FIGURE 3

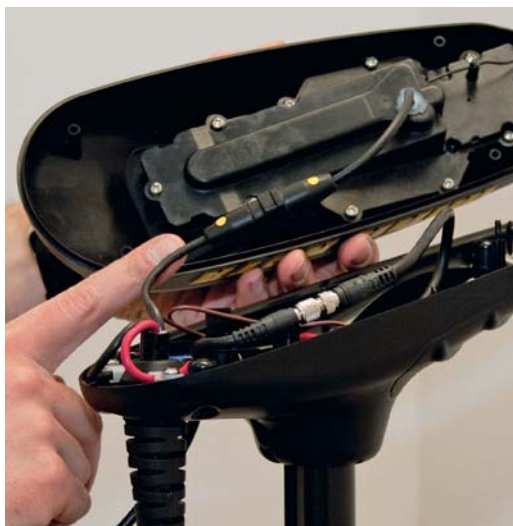

FIGURE 4



FIGURE 5

4. Plug the i-Pilot controller connector into the accessory connector as shown. (Figure 4) Be careful to orient connector properly prior to pushing together. The plug will click twice when pushing it together and the yellow end will be fully covered when installed properly.

Make sure connector is aligned properly. (Figure 5)

Make sure connector is fully seated as shown. (Figure 5)

5. Place the i-Pilot controller where the control box cover was installed and secure with supplied #8 screws. Do not over tighten screws. (Figure 6)
6. i-Pilot is now installed. Proceed to page 28 to verify your installation.



## i-Pilot Installation on PowerDrive V2 and Riptide SP

*\*Note: Once i-Pilot is installed the PowerDrive V2 foot pedal cannot be used again unless i-Pilot is fully uninstalled.*

1. Remove all power to the trolling motor.
2. If a **CoPilot** is installed, it must be removed as follows:
  - a. Disconnect motor connector and foot pedal connector from **CoPilot**. (Figure 7)
  - b. Remove the **CoPilot** receiver from the motor by removing both mounting screws. Do not replace these screws as the side plates will be removed in step 13 of this installation. (Figure 8)



FIGURE 6



FIGURE 7



FIGURE 8



FIGURE 9

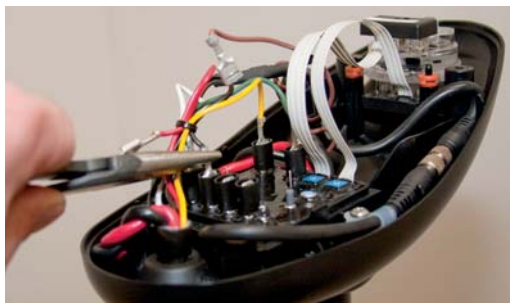

FIGURE 10

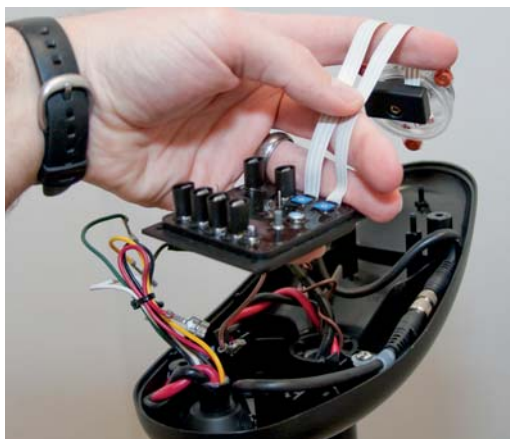

FIGURE 11

3. Remove control box cover screws and cover using Phillips screwdriver. (Figure 9)
4. If the trolling motor has **AutoPilot** it must be removed as follows:
  - a. Disconnect all six **AutoPilot** connectors from **AutoPilot** controller, using a needle-nose pliers and a utility knife to remove any heat shrink insulation that may exist. (Figure 10)
  - b. Remove the **AutoPilot** controller from the head of the trolling motor. (Figure 11)



# INSTALLATION

5. Remove grommet by pulling back on coil cord strain relief and pushing down on grommet until it pops out. (Figure 12)
6. Review the cables in the head of the trolling motor.
  - a. If a sonar cable is present, it must be routed around the outer perimeter of the control box as shown. The sonar ground wire should also be routed as shown. (Figure 13)
  - b. The motor power wires must be routed as shown. (Figure 13)



FIGURE 12 Sonar Cable (Universal Sonar Motors Only)

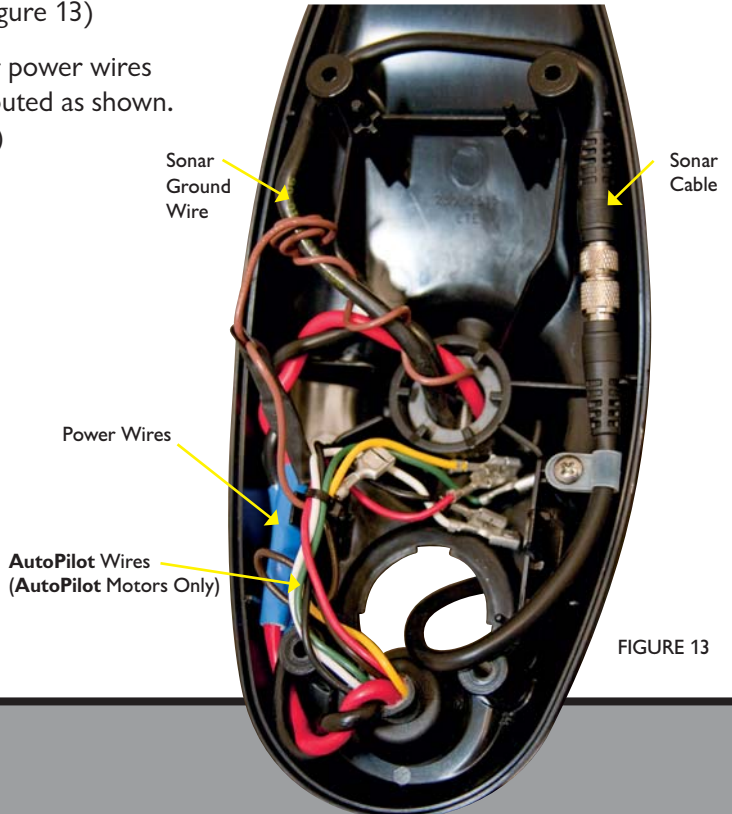

FIGURE 13



FIGURE 14 Insert **AutoPilot** wires into terminal holders.

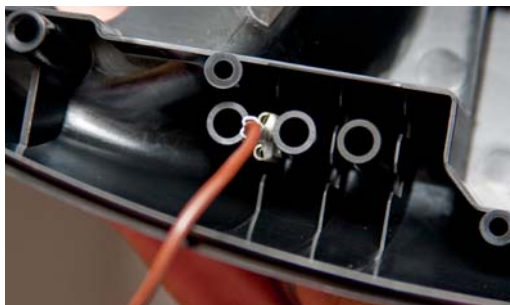
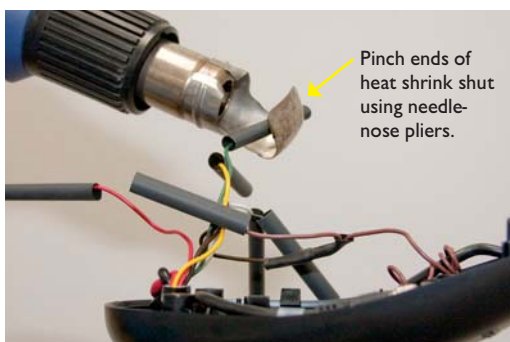

FIGURE 15



Pinch ends of heat shrink shut using needle-nose pliers.

FIGURE 16 Insulate and seal six **AutoPilot** wires on Riptide SP motors with supplied heat shrink.

7. If **AutoPilot** was removed, insulate the loose **AutoPilot** connectors as follows:
  - a. For PowerDrive V2 Motors: Using a needle-nose pliers push all six **AutoPilot** connectors that were disconnected in step 4 onto terminal holders located on the underside of the i-Pilot Controller. (Figure 14)

**IMPORTANT:** Pull on each wire to make sure it is secured properly. Loose wires can cause damage to i-Pilot Controller and the entire motor.

**AutoPilot** connectors must be placed onto holders exactly as shown. (Figure 15)





- b. For Riptide SP Motors:  
Apply heat shrink insulation supplied in bag assembly to the ends of all six loose **AutoPilot** connectors as shown. (Figure 16) Use a zip tie to bundle connectors together. Trim the zip tie and place connector bundle in the middle of the control box as shown. (Figure 17)
8. Route i-Pilot controller cable through grommet hole and through center of coil cord. (Figure 18)

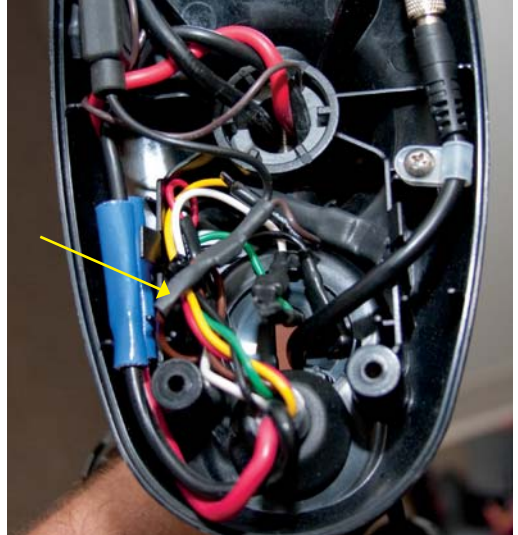

FIGURE 17 Place insulated **AutoPilot** wires in the bottom center of the control box as shown.

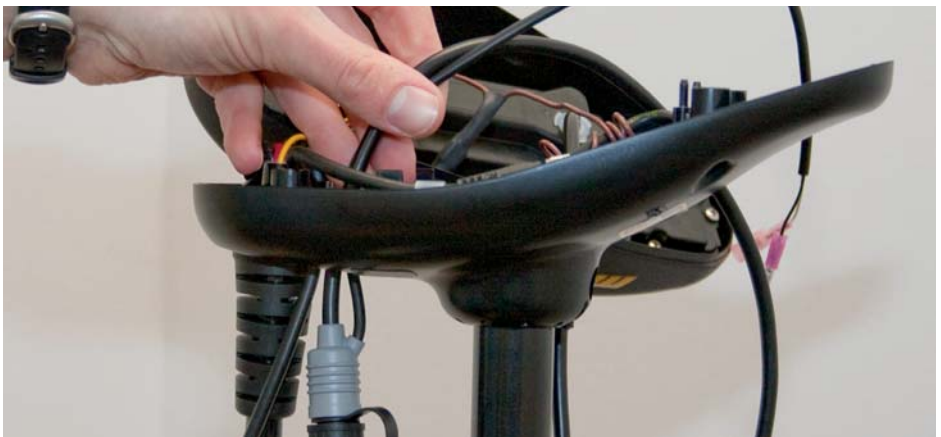

FIGURE 18



FIGURE 19



FIGURE 20



FIGURE 21

9. Install new grommet supplied with i-Pilot by snapping it into the hole located in front of the coil cord strain relief. The i-Pilot controller cable must be placed in the pass-through slot of the grommet. (Figure 19)
10. Place the i-Pilot controller where the control box cover was installed. Pull any extra controller cable out of the control box by gently pulling on the cable. (Figure 20)
11. Secure cover with supplied #8 screws. Do not over tighten screws. (Figure 21)



12. Secure the i-Pilot controller cable to the motor coil cord in all three locations shown using zip ties provided. (Figure 22) Trim zip ties using utility knife. Failure to secure cable will result in possible damage to the cabling during operation.
13. Remove the left and right side plates of trolling motor by loosening all four side plate screws using a Phillips screwdriver. (Figure 23)



FIGURE 22



FIGURE 23

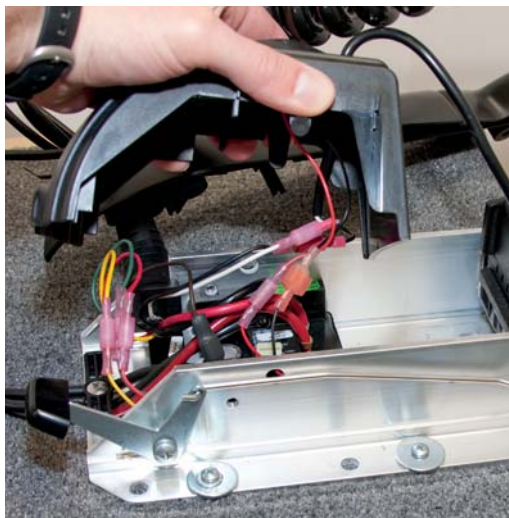

FIGURE 24

14. Remove center housing by pushing in on both sides and lifting up at the same time. This will expose the main control board and wiring. (Figure 24)

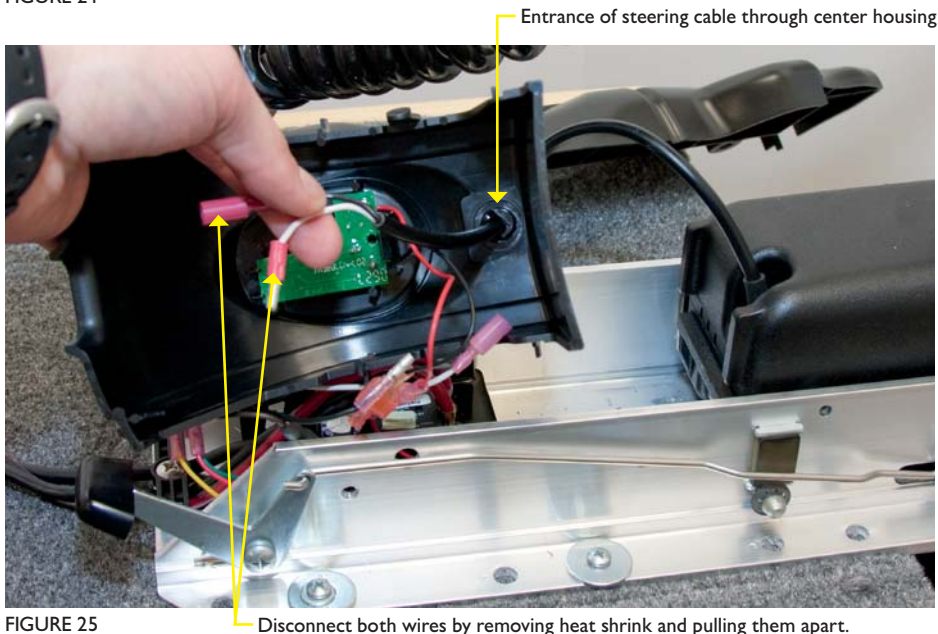

FIGURE 25

Entrance of steering cable through center housing

Disconnect both wires by removing heat shrink and pulling them apart.



15. The steering motor cable passes through the top of the center housing removed in step 14. This cable contains a black and white wire. Disconnect these two wires by pulling each connector apart. (Figure 25) Riptide SP motors will have this connections covered with heat shrink which must be removed with a utility knife.
16. Remove the cable strain relief that is secured to the base of the motor and install the i-Pilot controller steering cable into the open strain relief slot. (Figure 26)

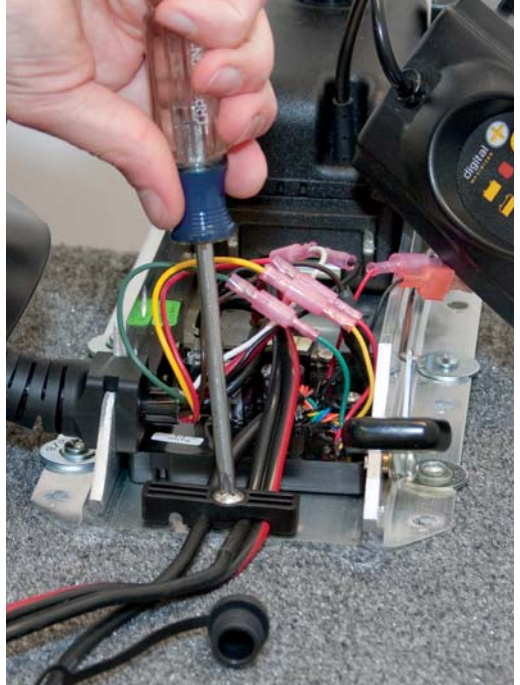
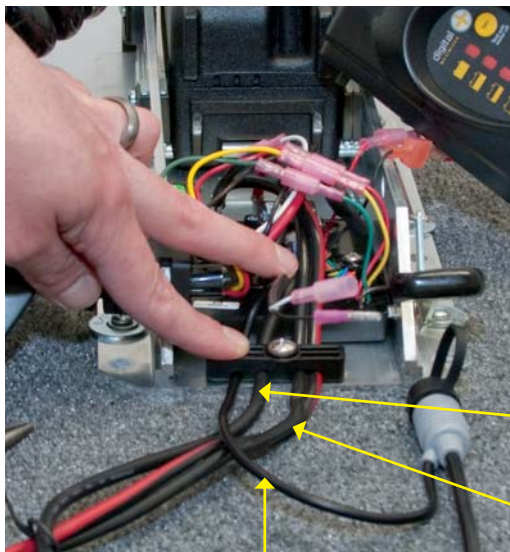

FIGURE 26





17. Reinstall the cable strain relief as shown. The i-Pilot controller steering cable should slide freely through the strain relief when installed properly. (Figures 27 and 28)

Foot Pedal Cable

Motor Power Cable

i-Pilot Controller Steering Cable

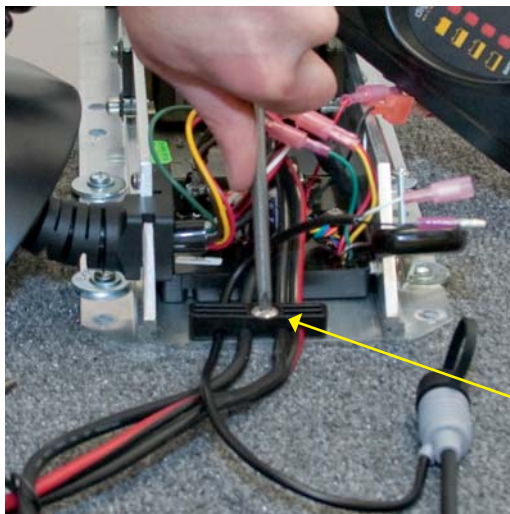

Reinstall strain relief screw.

FIGURE 27 and 28



18. Slide four pieces of heat shrink insulation over each side of the wires that were disconnected in step 15. (Figure 29)

Slide heat shrink over steering motor wires.

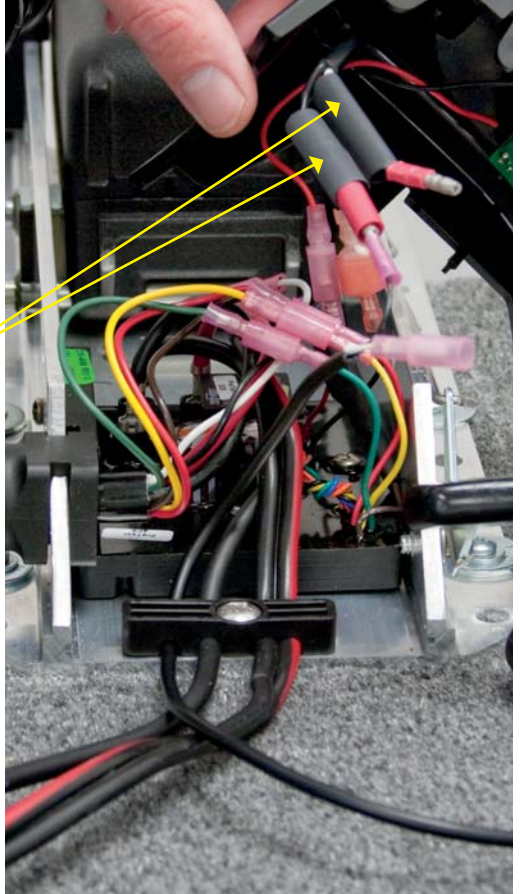
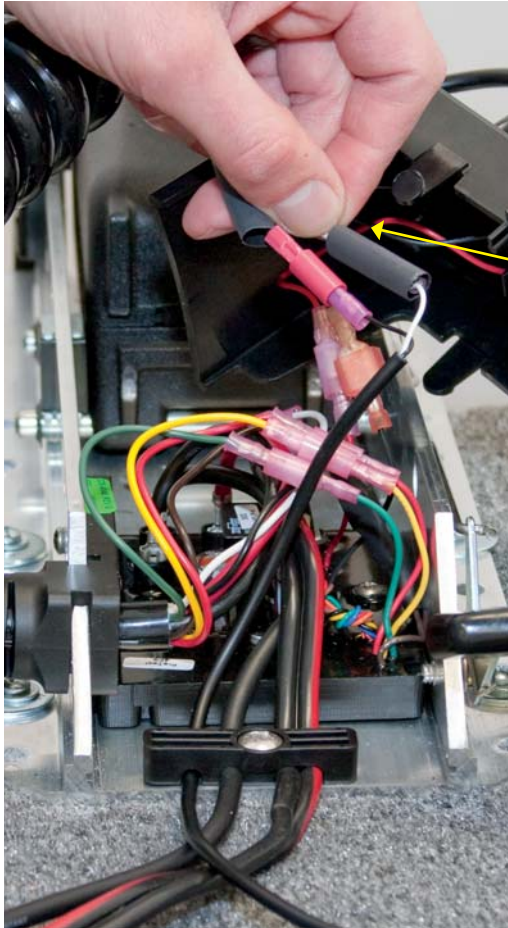

FIGURE 29



19. Connect the black and white wires from the i-Pilot controller cable to the back and white steering motor wires, making sure black is connected to black and white is connected to white. (Figure 30)

Connect steering wires:  
white to white  
black to black

FIGURE 30





20. Complete the installation by positioning the heat shrink over the connections and shrink down, using a heat gun or other heat source, being careful not to overheat any wire or parts.

**Seal connections with heat shrink.**

**IMPORTANT: DO NOT OVERHEAT WIRES OR SURROUNDING PARTS WHEN INSTALLING HEAT SHRINK!**

21. Reinstall center housing over control board by pushing it down until the side fingers lock into place. The new i-Pilot Controller steering cable should be exiting the cable exit hole at the center and bottom of the center housing. (Figure 31)



FIGURE 31



FIGURE 32



FIGURE 33



22. Reinstall both side plates using Phillips screwdriver. If a **Co-Pilot** was uninstalled, use new  $\frac{1}{4}$ -20 X  $\frac{5}{8}$ " Phillips screws provided. (Figure 32)
23. If a foot pedal is connected to the trolling motor, it must be disconnected. Once i-Pilot has been installed the foot pedal cannot be used unless i-Pilot is completely uninstalled.
24. Connect i-Pilot controller cable to the foot pedal connector, making sure the connector nut is tight. (Figure 33)

**IMPORTANT: DO NOT place dielectric grease or any type of lubricant in the connector.**

25. i-Pilot is now installed.





## VERIFYING INSTALLATION

It is important to verify your i-Pilot installation prior to going on the water. If this cannot be done, it is highly recommended that system verification be done in an open area on a calm day with a fully operational outboard motor for a backup means of powering your boat.

To verify that i-Pilot is working properly before going on the water, follow the steps below.

1. Trolling motor should be correctly installed and mounted to the bow of a boat.
2. The boat and trolling motor must be located outside and have a direct view of the sky to obtain GPS satellite signals.
3. Verify that all obstructions are away from the prop in all directions in both the stowed and deployed positions.
4. Connect power to the trolling motor.
5. Deploy the motor so the motor shaft is completely vertical.
6. i-Pilot will emit three long audio tones on startup.
7. Press any button on the i-Pilot remote.
8. The i-Pilot remote LCD will come on; prop speed and the GPS antenna icon will be displayed. It should take no longer than two minutes to obtain a GPS signal strength of at least one bar.



9. When i-Pilot is powered up, it starts to gather satellite information about its location. A minimum satellite signal level must be achieved before all i-Pilot functionality is available. This minimum level is one bar on the GPS signal icon. At initial startup only manual functions will be available.
10. Verify all manual functions by pressing     and .
11. If you experience any problems with any of the steps above, or cannot obtain a GPS satellite signal, refer to the troubleshooting section beginning on page 64.



## KNOWING YOUR REMOTE

### Layout

The i-Pilot remote is divided into four sections: **Manual Control**, **Tracks**, **Spot Lock**, and **Cruise Control/AutoPilot**. Buttons in the **Manual Control** section of the remote do not require a GPS signal to operate and give you full, immediate control over steering, speed and prop functions similar to a **CoPilot**. All other buttons require a minimum GPS signal strength of one bar in order to operate. Buttons located in the **Tracks** section are used for track recording and playback. **Spot Lock** buttons are located in the **Spot Lock** section. **Cruise Control/AutoPilot** are located in the **Cruise Control/AutoPilot** section.

### Construction



The remote is waterproof and floats in water.

### Range

The range of the remote will be greatly reduced if it is used near or mounted to any metal object including aluminum or steel. It is also recommended that the front end of the remote not be obstructed during use.

### Battery Life

Remote battery life is subject to frequency of use and is especially impacted by how often the LCD backlight is used.

When the remote battery is low,  will appear on the remote LCD. The **Backlight** button will be disabled when  is displayed to conserve battery power.

### Power

When a button is pressed on the remote it will automatically turn on. To turn the remote off press and hold  for three seconds. The remote will automatically turn itself off thirty minutes after the last button press if a learned i-Pilot controller is powered up and within transmitting range. The remote will turn off after three seconds if the i-Pilot controller is powered down or out of transmitting range.

# GETTING STARTED



## MANUAL CONTROL



Steer Left



Steer Right



Prop On/Off



Speed Down



Speed Up



**High Speed Bypass**  
Toggles the motor speed between its current setting and speed 10.



**Backlight**  
Turns the remote LCD backlighting on for six seconds.

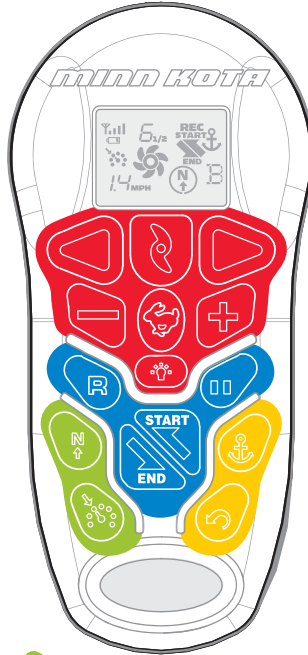

## TRACKS



**Track to End**  
Navigates to the nearest location on a previously recorded track and follows it to its end.



**Track to Start**  
Navigates to the nearest location on a previously recorded track and follows it to its start.



**Track Record**  
Starts and ends the recording of a track to a selected memory location.



**Record Pause/Escape**  
Pauses the recording of a track and then resumes the recording when pressed again.



## CRUISE CONTROL/ AUTOPILOT



**Advanced AutoPilot and AutoPilot**  
Turns Advanced AutoPilot on and off when pressed once. Turns AutoPilot on when held for two seconds.



**Cruise Control**  
Turns cruise control on and off using the current GPS speed as the target speed.



## SPOT LOCK



**Spot Lock**  
Turns spot lock on and records it to a memory location.



**Spot Lock Recall**  
Recalls a spot lock location from memory and turns spot lock on.

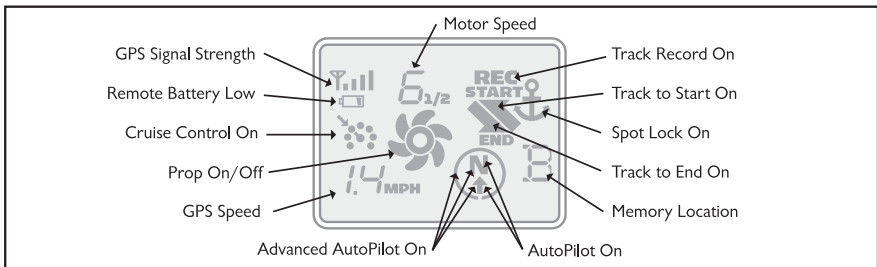

## Remote Battery Replacement

*\*NOTE: Panasonic brand batteries will not work with the i-Pilot remote.*

1. Make sure hands are clean, dry and static free. Discharge any static electricity by touching a metal object that is grounded. *\*Static electricity can damage the circuit board.*
2. With the remote upside down remove the six case screws.
3. Remove the bottom cover.
4. While pushing down in the middle of the circuit board lift the old battery out and replace with a new CR2450 coin cell battery.
5. Replace back cover and reinstall case screws. Do not over tighten case screws as it will damage the remote enclosure. Factory torque setting is seven inch pounds.

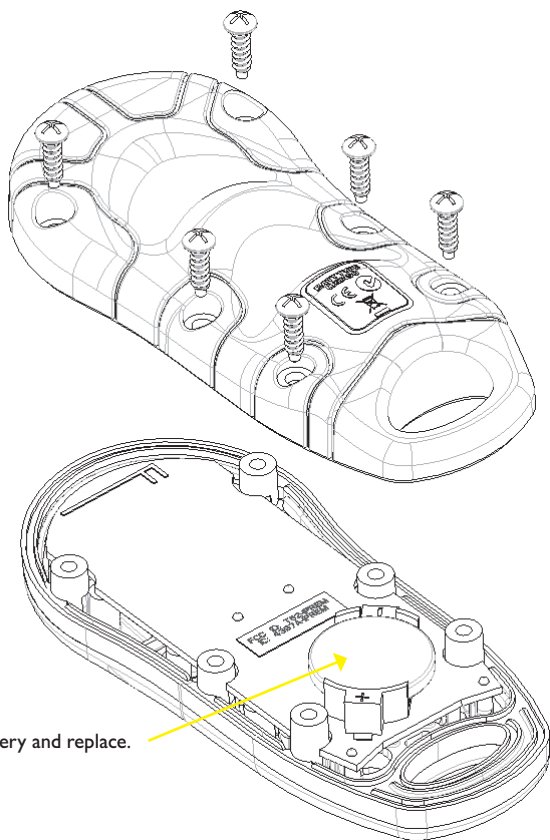





## KNOWING YOUR I-PILOT CONTROLLER

### Construction

The i-Pilot controller contains a very sensitive digital compass and is where all GPS satellite and i-Pilot remote signals are received. It is very important that the controller have a clear view of the sky in all directions and has a clear line of sight to the remote for optimum performance. All electronics within the controller enclosure are completely sealed.





### Remote Learning

The i-Pilot remote is prelearned to the controller from the factory. The top of the controller has a single learn button to allow additional remotes to be added to the system. To learn additional remotes:

1. Power up the trolling motor.
2. Push and hold the learn button down. A steady audio tone will be heard while holding this button.
3. While holding the learn button down push any button on the remote being programmed. Three short chirps will be heard when the remote is successfully learned.

A remote can only be learned to one controller at a time. A controller can have an unlimited number of remotes learned to it.

## Audio Modes

The i-Pilot Controller also contains an internal speaker which can be programmed to work in two different audio modes. The speaker is programmed to operate in audio mode one from the factory. To enable different audio modes hold  and  down at the same time for three seconds. For an explanation of each audio mode and their sounds see the table below.

WHAT CONDITION CAUSES IT	AUDIO MODE	AUDIO PATTERN
Startup	Modes 1 and 2	4 Short beeps
Manual prop on	Mode 2	Single beep
Manual prop off	Mode 2	Double beep
Speed + (when less than max speed)	Mode 2	Single beep
Speed - (when greater than speed 0)	Mode 2	Single beep
High Speed Bypass enable	Mode 2	Single beep
High Speed Bypass disable	Mode 2	Double beep
Button press for any of these (enable or disable): REC, Pause, Track to Start, Track to End, AutoPilot, Cruise Control, Spot Lock, Spot Lock Recall	Mode 2	Single beep
Moving more than a quarter mile from the last track point while in Record Pause mode	Mode 2	Error
When GPS Signal Strength goes to no bars while in a GPS-based mode	Mode 2	Error



WHAT CONDITION CAUSES IT	AUDIO MODE	AUDIO PATTERN
Attempting to enable a GPS feature when no signal strength bars are shown	Mode 2	Error
Attempting to replay a Track or recall a Spot Lock location when the boat is beyond the minimum distance	Mode 2	Error
MOM button on the footpedal is pressed and a remote button press attempts to override it	Mode 2	Error
End of track attained during track playback (in conjunction with cancelling mode and turning the prop off)	Mode 2	High-Low, High-Low, High-Low
Switch to Audio Mode 1	Modes 1 and 2	Single beep
Switch to Audio Mode 2	Modes 1 and 2	Double beep
Learn button is pressed	Modes 1 and 2	Steady tone
Learn successfully completed	Modes 1 and 2	4 Longer beeps

## Power

The i-Pilot controller will turn on whenever the trolling motor has power. For Terrova and Riptide ST motors this is when the green system ready light is on. For PowerDrive V2 and Riptide SP motors this is whenever the motor is connected to power.

*\* For this reason it is very important to disconnect a PowerDrive V2 or Riptide SP motor from power when not in use or battery drain will occur.*

## Accuracy

The accuracy and responsiveness with which i-Pilot controls your boat is highly dependent upon many variables. Just a few of these variables and their general effects on responsiveness and accuracy are given below so that the behavior of the system can be understood.

VARIABLE	EFFECT
Ratio of motor thrust to boat weight	Excessive thrust on a smaller boat can cause i-Pilot to overcorrect. Not enough thrust on a large boat can cause i-Pilot to respond slowly.
Wind	Excessive wind and/or current can reduce i-Pilot's positioning accuracy.
GPS signal strength	The greater number of GPS signal bars the greater the accuracy.
Trolling motor battery power level	A fully charged battery will give the best performance.



## System Startup

Once you have verified i-Pilot's installation it's time to start using it on the water. Follow these simple steps each time you power up your trolling motor for successful operation:

1. Connect trolling motor to power.
2. Deploy trolling motor into water.
3. Push any button on your remote. The remote LCD will show prop speed and GPS signal strength.

4. You are now able to use all manual functions:



5. After i-Pilot has obtained a minimum GPS signal strength of one bar, all remaining functions will become available.

# MANUAL CONTROL FUNCTIONALITY



This section describes all **Manual Control** functions of i-Pilot. A manual function is one in which the operator takes full control of the function such as manually steering the motor in a desired direction or manually adjusting the prop speed to the desired setting. Any of these functions do not require a GPS signal.

## How Do I . . . Turn the Motor On/Off?

### Motor On/Off

To turn the motor on or off press .

The prop icon on the LCD will be on if the prop is enabled and off if the prop is disabled. With the prop enabled, the icon will be stationary if the motor speed is zero and the icon will rotate if the motor speed is greater than zero.

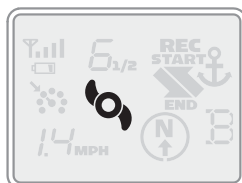

Prop Enabled

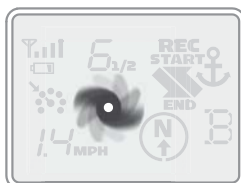

Motor Speed Greater Than Zero





Pressing the **MOM** or **CON** button on the foot pedal will adjust the motor speed setting to the foot pedal speed setting.





## How Do I . . . Control Motor Speed?

### Motor Speed Control

#### Increase Motor Speed

To increase the motor speed push  on the remote. Each push of  will increment the motor speed by  $\frac{1}{2}$  to a maximum of 10.

#### Decrease Motor Speed

To decrease the motor speed push  on the remote. Each push of  will decrement the motor speed by  $\frac{1}{2}$  to a minimum of 0.

The remote LCD will display the current motor speed setting. This is not to be confused with the GPS speed which is also displayed on the remote LCD.



Motor Speed

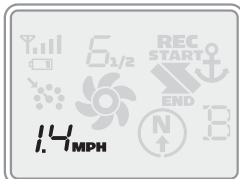

GPS Speed



While the **MOM** button is pressed on the foot pedal, all speed and prop changes from the i-Pilot remote are ignored.

How Do I . . . Steer the Motor?

## Motor Steering Control

### Steer Left

To steer the motor to the left press .

### Steer right

To steer the motor to the right press .

If a steering button is held down for more than six to eight seconds, the steering will stop to prevent the coil cord from wrapping on the motor.







How Do I . . . Engage High Speed Bypass?

## High Speed Bypass Operation

### Engage

Pressing  will set the motor speed to maximum immediately.

### Disengage

Pressing  again will set the motor speed to the value it was at previously.

*\*Note: High Speed Bypass does not enable or disable the prop.*

How Do I . . . Turn LCD Backlighting On?

## LCD Backlight Button

To turn on LCD backlighting press .

The backlight will turn off eight seconds after the last button press to conserve battery power.

# UNDERSTANDING HOW THE I-PILOT SYSTEM WORKS

## Navigation

i-Pilot uses GPS satellite signals as well as digital compass data to know where it is, where it is heading and the direction the motor is pointing. Since i-Pilot depends on GPS satellite signals for navigation, a minimum GPS signal level of one bar is required in order for GPS navigation controls to be enabled. Best results are achieved when a GPS signal level of four bars can be obtained.



In simple terms, i-Pilot remembers and creates points to navigate your boat automatically. i-Pilot also uses a method of GPS navigation called arrival circles. These imaginary circles allow i-Pilot to understand when it has drifted away from a point and when it has arrived at a point. The size of the arrival circles vary depending on GPS signal strength, thus the greater the signal strength the smaller the arrival circles.

## Tracks

Tracks are made of many points that i-Pilot records when recording a track. The distance between these points varies based on GPS signal strength and the speed at which you record the track. When a track is played back, i-Pilot uses the track points and arrival circles to navigate the track.



## Memory

i-Pilot has the capability of storing up to three individual tracks (each two miles in length) and three individual **Spot Lock** locations. These locations are stored in memory even when power is removed from the system. **Spot Lock** and **Track** memory locations are separate from each other and they cannot over write each other. Memory locations are identified on the remote LCD with an icon shown as A, B or C. When the memory icon is flashing, a different location can be selected by pressing  or .

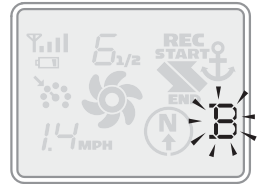

## HOW SPOT LOCK WORKS

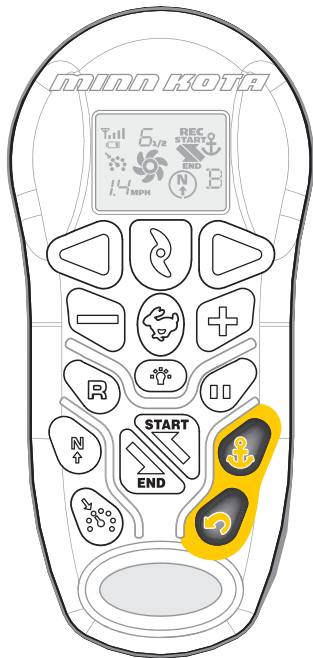



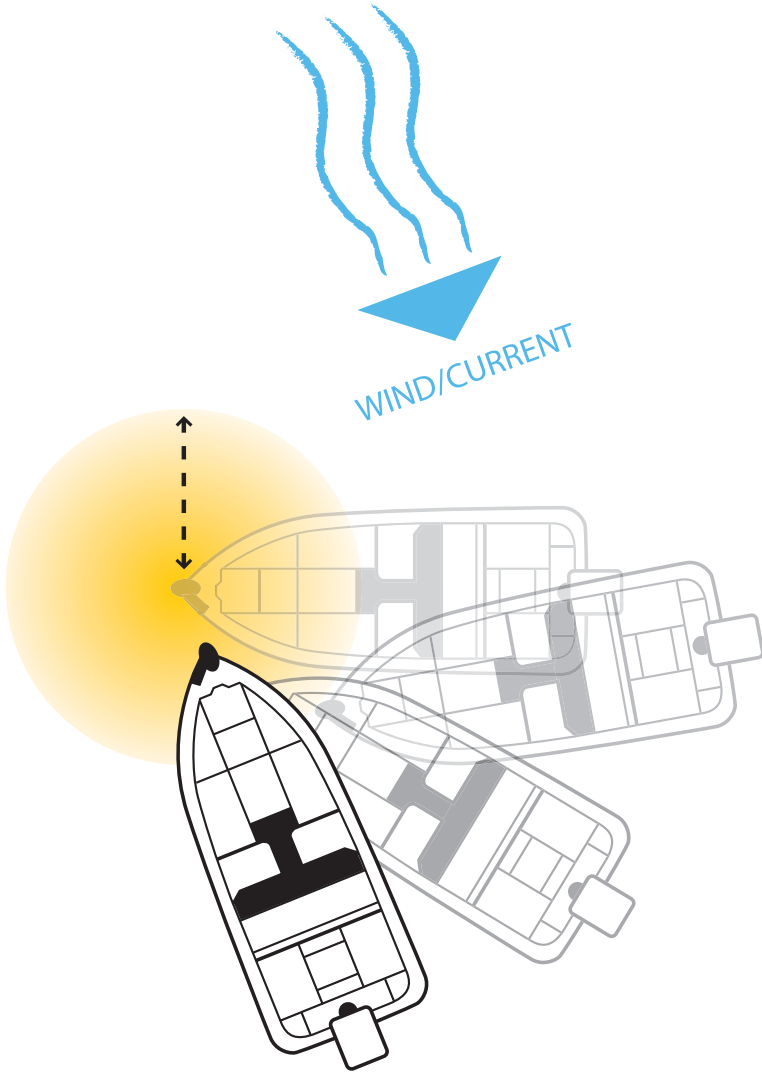

### Spot Lock

**Spot Lock** uses a single point as a reference for the spot you want to stay on. This point is recorded and stored into one of the three memory locations when the **Spot Lock** button is pushed. Around the **Spot Lock** location i-Pilot uses an arrival circle to determine prop speed and direction. If i-Pilot sees it is within the circle, it will adjust the motor speed to zero. If i-Pilot sees it is outside of the circle, it will control motor speed in an attempt to get the boat back into the circle.



## ▶ ENGAGING SPOT LOCK

1. Press  on the remote.
2. The Memory Location icon will flash on the remote LCD for three seconds, allowing you to choose a memory location by pressing  or . Pressing  again or waiting for three seconds accepts the memory location.

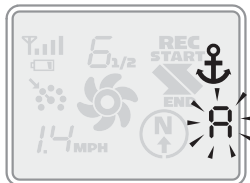

## ▶ DISENGAGING SPOT LOCK





1. To disengage **Spot Lock** press any of these buttons:



Pressing any foot pedal button will disengage Spot Lock.



## ▶ RE-ENGAGE A SAVED SPOT LOCK LOCATION

1. Manually navigate the boat to within a quarter mile of the saved **Spot Lock** location. Due to safety reasons, i-Pilot will not re-engage a saved **Spot Lock** location greater than a quarter mile away.
2. Press  on the remote.
3. The Memory Location icon will flash on the remote LCD for three seconds allowing you to choose a memory location by pressing  or . Pressing  again or waiting for three seconds accepts the memory location.

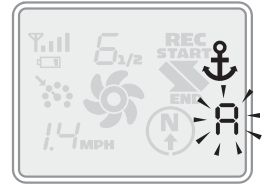

## ▶ SPOT LOCK ESCAPE

1. If the **Spot Lock** button is accidentally hit, press  or any manual navigation button within three seconds to cancel the command.

### Using Spot Lock with Other i-Pilot Functions

Since **Spot Lock** takes over full control of the motor, it cannot be used in combination with other i-Pilot functions.



The momentary button on the foot pedal will not function when Spot Lock or Spot Lock Recall is engaged.

# HOW CRUISE CONTROL WORKS



## Cruise Control

(Advanced Functionality) i-Pilot automatically controls the motor speed to maintain a constant GPS speed.







Adjusting the motor speed or pressing the CON button from the foot pedal will disengage Cruise Control.





## ▶ ENGAGING CRUISE CONTROL

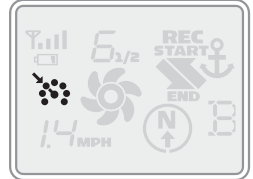

1. Press  on the remote.
2. The current GPS speed will flash, displaying your current speed as the target GPS speed on the remote LCD for three seconds.
3. Press  or  to increase or decrease the target speed or press  again to engage **Cruise Control** immediately.



## ▶ DISENGAGE CRUISE CONTROL

1. Pressing  will disengage **Cruise Control**.

## ▶ ADJUSTING TARGET SPEED WITH CRUISE CONTROL ENGAGED

1. With **Cruise Control** engaged press  or  to adjust the target speed by 0.1 MPH increments.

### Using Cruise Control with Other i-Pilot Functions

**Cruise Control** can be used in combination with **Advanced AutoPilot**, **AutoPilot**, **Track Recording**, and **Track Playback**.

## HOW AUTOPILOT WORKS



Two different versions of **AutoPilot** are available **Advanced AutoPilot** and **AutoPilot**. There are distinct differences between the two **AutoPilots** and how they control your boat.

### AutoPilot

**AutoPilot** uses an internal compass to provide heading lock. When **AutoPilot** is on, it keeps the motor pointed in the same compass direction. If a manual steering correction is made, **AutoPilot** locks onto the new compass heading to which the boat was steered. This method of heading tracking does not take into account external forces such as a side wind or currents, which can allow side drift.

# AUTOPILOT



AUTOPILOT  
HEADING



POSSIBLE DEVIATION  
DUE TO WIND/CURRENT

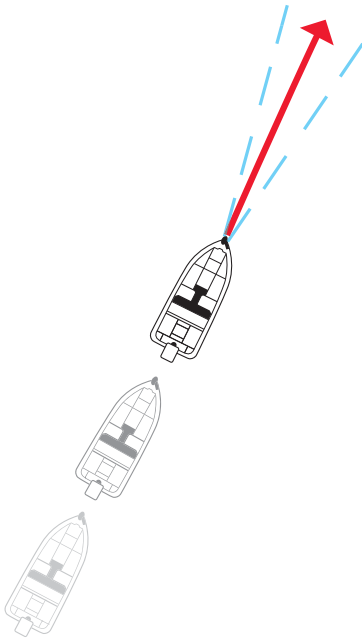
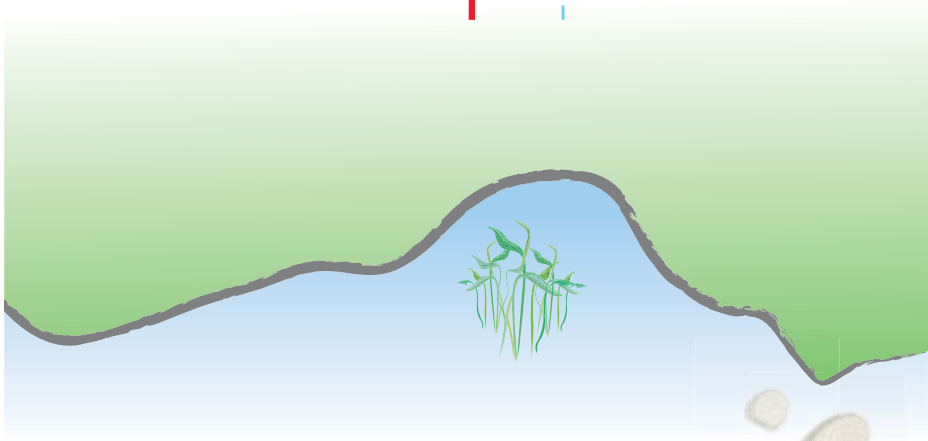

# HOW ADVANCED AUTOPILOT WORKS



## Advanced AutoPilot

**Advanced AutoPilot** not only uses compass heading but also GPS signal data to correct for cross winds, current and other external forces to keep the boat on a straight line. When **Advanced AutoPilot** is turned on, it generates a set of GPS points in a straight track line in the heading direction. i-Pilot now navigates to each individual point on this track line. When the user steers to a new heading, a new track line of GPS points are laid down in the new heading direction.

# ADVANCED AUTOPILOT





ADVANCED AUTOPILOT  
HEADING

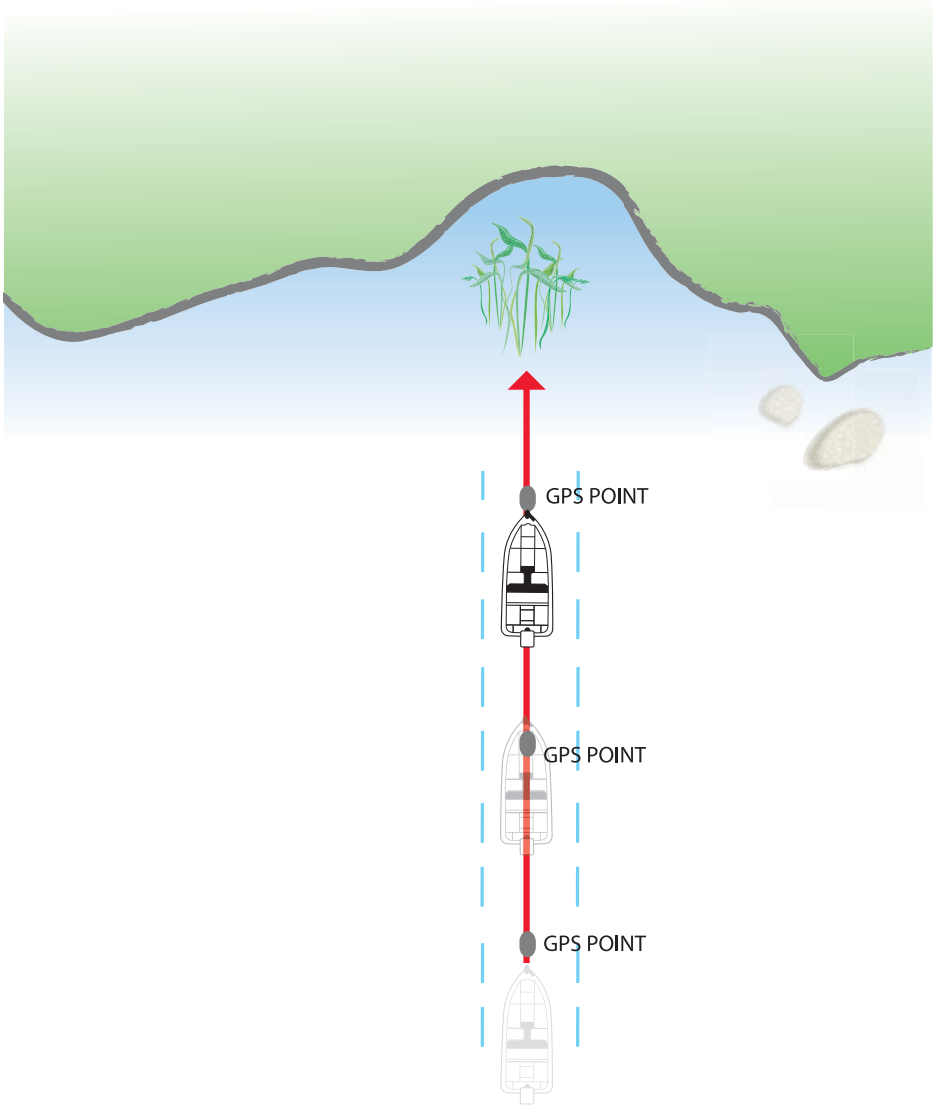

POSSIBLE DEVIATION  
DUE TO WIND/CURRENT



## ▶ ENGAGING ADVANCED AUTOPILOT AND AUTOPILOT

1. To engage **Advanced AutoPilot**, press  once. To engage **AutoPilot**, press and hold  for two seconds.
2. The **Advanced AutoPilot** or **AutoPilot** icon will be displayed on the remote LCD.
3. To adjust desired heading, manually steer motor to new heading. i-Pilot will lock onto new heading.



Advanced AutoPilot



AutoPilot

### Using Advanced AutoPilot and AutoPilot with Other i-Pilot Functions

**Advanced AutoPilot** and **AutoPilot** can be used in combination with **Cruise Control** and while recording a track.



Advanced AutoPilot can be turned on by pressing the AP button on the foot pedal.



## Which AutoPilot Do I Use and When?

With all the external variables, this question can be difficult to answer. Both **AutoPilots** have their benefits based on the type of fishing and bait presentation desired.

**Advanced AutoPilot** will keep the boat on a true straight path in most conditions. When very extreme conditions exist such as very strong winds or current, the trolling motor may not have enough power to control the boat smoothly. In these extreme cases it may be best to use **AutoPilot** and let the boat move with the wind or current if the motor is not powerful enough to overcome it.

**AutoPilot** helps you maintain a constant heading but does not compensate for wind or currents.

Both **Advanced AutoPilot** and **AutoPilot** are valuable tools the fisherman can use for accurate and precise bait presentation. We highly recommend getting on the water and trying both **Advanced AutoPilot** and **AutoPilot** in various fishing situations and applications. With experimentation and time you will find which **AutoPilot** works best for you in a given situation.



**AutoPilot cannot be turned on by using the AP button on the foot pedal.**

# HOW TRACK RECORDING AND PLAYBACK WORK

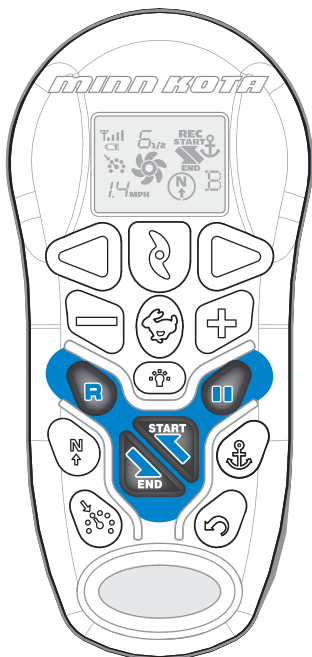

## Track Recording and Playback

When the **Track Record** button is pressed, i-Pilot starts to record GPS position data in the form of track points. The distance between these points varies based on the speed of the boat and the GPS signal strength. The very first track point recorded is called the start. The last point recorded is called the end. i-Pilot sees a recorded track as a series of these track points. When a **Track to Start** or **Track to End** button is pushed, i-Pilot will navigate to the nearest track point. Once this nearest track point is reached, it will then follow the track points in sequence back to either the start or end based on which button was pressed. Once the end or start track point is reached, i-Pilot automatically exits from the **Track to Start** or **Track to End** function. During track playback, i-Pilot takes control over all steering functions; speed can be manually controlled or the **Cruise Control** function can also



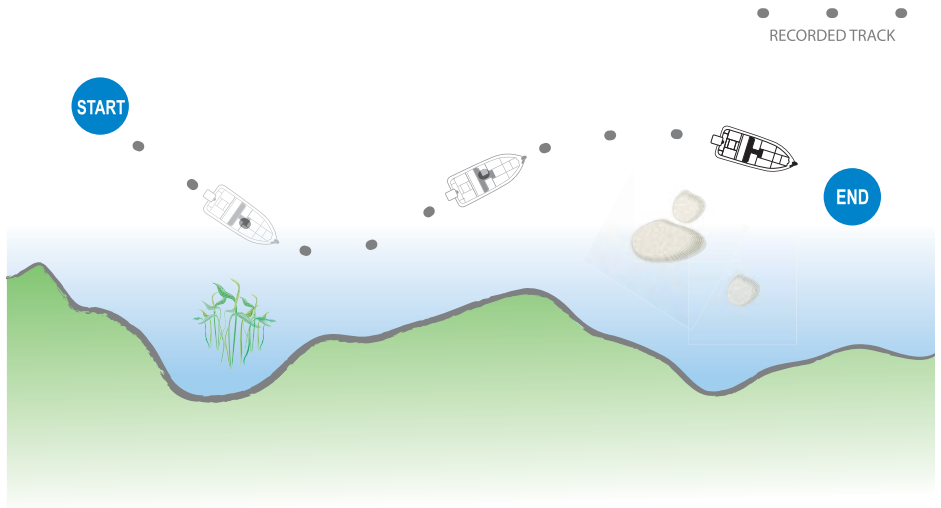



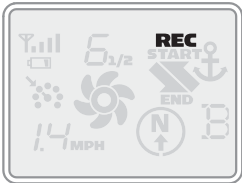

be used. The motor speed must be set high enough in order to stay on the track given wind, current and other external forces.

i-Pilot can also pause the recording of a track. When the recording is paused, i-Pilot temporarily stops recording any new track points. When track recording is resumed, i-Pilot records new track points. Due to the nature of pausing a recording, there may be a large separation distance between two track points or two track points lying on top of one another where the pause occurred. This can cause erratic motor steering therefore it is very important to know where the pause button was pressed and to resume the recording just ahead of that location. If while paused, the separation distance exceeds a quarter mile, the recording will automatically stop.

## ▶ RECORDING A TRACK

1. Press on the remote.
2. The Memory Location icon will flash on the remote LCD for three seconds, allowing you to choose a memory location by pressing or . Pressing again or waiting for three seconds accepts the memory location.
3. The REC icon will be displayed on the remote LCD. Remember this will be the start point on the track.
 
4. Navigate the boat along the desired path or course. **AutoPilot** and/or **Cruise Control** can be used while recording a track.
5. Press on the remote again to stop the recording. The recording will end automatically if the two-mile distance limit is reached for the track or if one of the following buttons are pressed: or .

## ▶ PAUSE AND RESUME A RECORDING

1. While recording a track press .
2. The record icon will flash on the remote LCD.
3. i-Pilot has now paused the recording of the track.
4. If the boat moves farther than a quarter mile from where  was pressed, the recorded track will be ended and saved to the memory location previously selected.
5. When ready to resume recording, navigate the boat just ahead of where  was pushed. Failure to do this may cause erratic play back of a track.
6. Push .
7. The record icon will stop flashing on the remote LCD.
8. i-Pilot is now recording again and adding to the track that was paused.

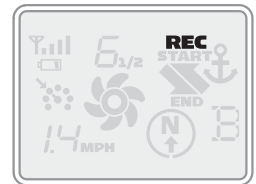
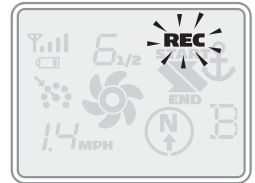

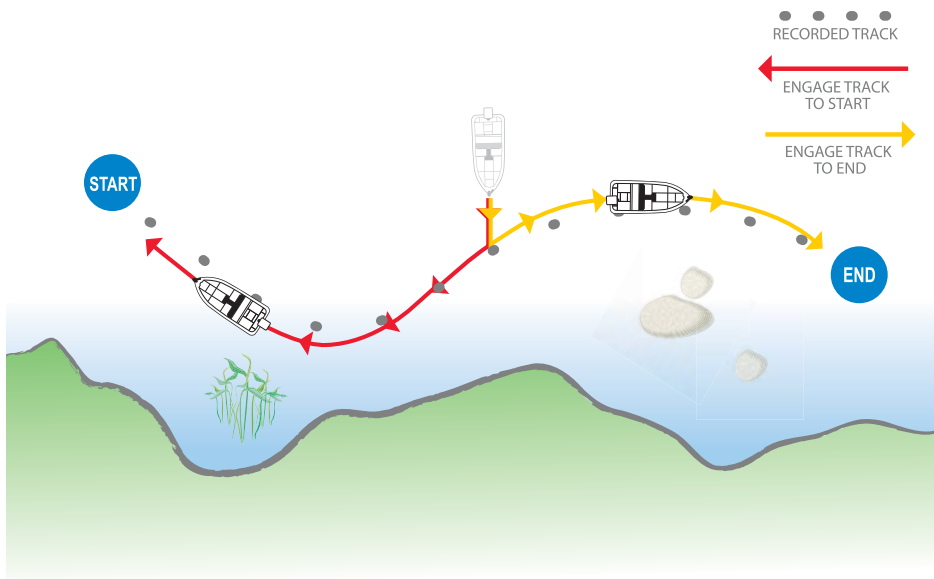





***i-Pilot* TIPS**



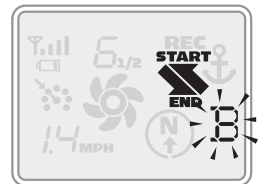

You can switch directly between Track to Start and Track to End. This allows you to concentrate on productive sections of a track.

## ▶ REPLAYING A TRACK (TRACK TO START / TRACK TO END)

1. Manually navigate the boat to within a quarter mile of the saved track. Due to safety reasons, i-Pilot will not re-engage a saved track greater than a quarter mile away.
2. Press  or  on the remote.
3. The Memory Location icon will flash on the remote LCD for three seconds, allowing you to choose a memory location by pressing  or . Pressing the button pressed in step 2 again or waiting for three seconds accepts the memory location.
4. Adjust motor speed to desired setting to engage and navigate track automatically.



## ▶ RECORD, TRACK TO END AND TRACK TO START ESCAPE

1. If   or  is accidentally hit, press  within three seconds on the remote to cancel the command.



Steering left or right and turning Advanced AutoPilot on with the foot pedal will disengage Track to Start or Track to End.

## FREQUENTLY ASKED QUESTIONS

**Q. Does i-Pilot record the speed I am traveling when recording a track?**

A. No. i-Pilot only records its location during track record. It is up to the user to set the desired speed manually or with **Cruise Control**.

**Q. Why doesn't my GPS Signal Strength icon always show all four bars?**

A. GPS signal strength is impacted by many influences including: i-Pilot controller having a clear view of the sky (especially to the southern sky), boat being located alongside a high bank and your geographic location.

**Q. Is i-Pilot compatible with CoPilot?**

A. No. None of the components between the two systems are compatible with each other.

**Q. Does the remote float?**

A. Yes.

**Q. When I turn on the remote, the Low Battery Indicator comes on along with all the other icons, is my battery low?**

A. Not necessarily. When the remote first powers up, all of the icons come on automatically for a short period of time. This gives the user the opportunity to view all of the icons.

**Q. How long of a track can I record?**

A. Each individual track location (A, B or C) can be up to two miles in length.

**Q. Can I use multiple remotes with my i-Pilot?**

A. Yes, you can use an unlimited number of remotes simultaneously. Remember to learn each new remote to the i-Pilot controller.

**Q. Why does the LCD screen of the remote have dark blotches on it when I wear my sunglasses?**

A. Polarized sunglasses can dramatically affect the way an LCD looks to the human eye.

**Q. Can I control how fast i-Pilot takes me back to a Spot Lock location when using Spot Lock Recall?**

A. No, **Spot Lock** and **Spot Lock Recall** are fully automatic functions that take full control of motor steering and speed.

**Q. Where can I purchase additional remotes?**

A. Your local Minn Kota retailer should carry additional remotes.

**Q. If I turn off the remote, will i-Pilot continue to operate?**

A. Yes. The i-Pilot Controller will continue in its current state of operation until the user makes a change either with the remote or foot pedal (Terrova only).

**Q. Where are the three tracks and Spot Lock locations stored?**

A. In the i-Pilot Controller.

## TROUBLESHOOTING

### General Troubleshooting

**Problem:** The motor is making erratic steering corrections while in AutoPilot, Spot Lock or Track to Start/End.

**Solution:** Be sure to keep all ferrous metallic objects away from the i-Pilot controller as they will have an impact on the built-in compass. Such objects include: anchors, metal framework, etc.

**Problem:** When a button on the remote is pressed the motor doesn't always respond.

**Solutions:** Check if the low battery indicator is on. If so, replace the remote's battery. Check for large obstructions between the remote and the motor.

**Problem:** I press a button on the remote and nothing happens.

**Solution:** Could be a dead battery in the remote. If the battery was just replaced, open the remote case and verify that all the internal components were properly reinstalled.

**Problem:** I press a button on the remote and all the icons come on for a few seconds then it shuts off.

**Solutions:** Verify that the motor is powered up (for Terrova and Riptide ST, it must also have its system ready light on). Go through the learn process for the remote (see page 33 for the procedure).

**Problem:** i-Pilot won't let me turn on certain features like: Advanced AutoPilot, Record, Track to Start/End or Spot Lock.

**Solution:** Verify that the GPS Signal Strength icon on the LCD shows at least one bar. If there are no bars, i-Pilot will not allow these GPS-based features to be enabled.



**Problem:** The remote LCD backlighting will not come on.

**Solution:** Check if the low battery indicator icon is on. Backlighting is disabled when a low battery level is detected. Replace the battery.

**Solution:** The **Backlight** will not come on if the remote is not currently communicating with the i-Pilot Controller.

## Spot Lock

**Problem:** **The boat doesn't seem to keep close enough to the recorded Spot Lock location.**

**Solution:** Verify the trolling motor batteries are sufficiently charged

**Solution:** Check for weeds on the prop.

**Solution:** In more extreme wind and current conditions, the boat will tend to stabilize a little ways down wind from the intended location. Relock the location the same distance upwind and expect that the boat will drift some in the downwind direction.

## Cruise Control

**Problem:** **The GPS speed displayed on the remote is different than what my other GPS system shows.**

**Solution:** If you are using **Cruise Control** with **Advanced AutoPilot** or **Track to Start/End**, i-Pilot calculates the actual speed in the intended direction of travel which may differ from your GPS reported speed.

**Problem:** **Cruise Control isn't holding the target speed close enough.**

**Solution:** Verify the trolling motor batteries are sufficiently charged.

## AutoPilot

**Problem:** When in **Advanced AutoPilot** in strong winds, there is quite a bit of back and forth movement in the boat.

**Solution:** While **Advanced AutoPilot** will keep your boat on a true heading, it may be at the expense of the boat having to continuously move to get back on the correct course. In these extreme conditions you may be better off using **AutoPilot** and correcting for the wind manually.

**Problem:** I press and release the **Advanced AutoPilot** button and the system goes into **AutoPilot** instead of **Advanced AutoPilot**.

**Solution:** If the GPS Signal Strength indicator shows no bars, then pressing and releasing the **AutoPilot** button will enable **AutoPilot** automatically instead of requiring that the button be held for two to three seconds like when GPS is present.

## Track Record and Playback

**Problem:** While in **Track to Start/End** the propeller suddenly stopped.

**Solution:** Verify you did not accidentally enable another automatic feature such as **AutoPilot** or **Spot Lock**.

**Solution:** When the end (or start) of the track is achieved during playback, i-Pilot will automatically turn off the motor along with canceling **Track to Start/End**.

**Problem:** While in **Record** mode, the recording suddenly stopped.

**Solution:** You may have reached the two mile limit for recording a track.

## **Terrova/Riptide ST:**

**Problem:** Pressing a button on the remote causes all the icons to come on for a few seconds then they all go off.

Solution: Ensure the motor is deployed and that the System Ready light on the motor is illuminated.

Solution: Verify that the i-Pilot controller is properly plugged in.

Solution: Try to relearn the remote to the controller.

Solution: Cycle power to the motor by stowing and deploying the motor verifying that the System Ready light comes back on when the motor is deployed

## **PowerDrive V2 /Riptide SP:**

**Problem:** Pressing a button on the remote causes all the icons to come on for a few seconds then they all go off.

Solution: Verify that the i-Pilot controller is properly plugged into the footpedal connector on the motor.

Solution: Try to relearn the remote to the controller.

Solution: Cycle power to the motor.

**Problem:** Steering does not work properly or at all.

Solution: Verify that the steering wires from the i-Pilot cable are properly connected directly to the two-wire cable coming from the steering housing.

## GLOSSARY

**Accessory Connector:** The accessory connector is a small sealed connector used on the Terrova and Riptide ST family of motors. This connector allows for easy waterproof installation of any Minn Kota Terrova and Riptide ST accessories.

**Center Housing:** A plastic center housing exists in the center of the trolling motor mount. This center housing covers and protects mechanical and electrical components from the environment. The center housing is temporarily removed from PowerDrive V2 and Riptide SP motors during i-Pilot installation.

**CoPilot:** Co-Pilot is a wireless motor control accessory from Minn Kota available for all Terrova, PowerDrive V2, Riptide ST and Riptide SP lines of motors. The accessory allows for wireless adjustment of all basic motor control functions. The Co-Pilot accessory must be removed from a PowerDrive V2 and Riptide SP motor upon i-Pilot installation. Any Co-Pilot accessory installed on a Terrova or Riptide ST motor is electrically disabled once i-Pilot is installed.

**Control Box Cover:** The control box cover is a plastic cover installed on the top head of the motor. The cover protects the inner wiring and electronics from the environment. This part is replaced by the i-Pilot controller.

**GPS:** GPS is an acronym for Global Positioning System. GPS provides accurate position (latitude, longitude, altitude) information virtually anywhere on the earth through satellite technology and personal receivers on the ground. A series of geosynchronous satellites broadcast a unique signal toward the earth once per second. A GPS receiver, which is used in i-Pilot, receives the signals from these satellites and is able to determine position based on very slight differences in the time each signal is received and the receiver's knowledge of the location of each of the satellites.

**GPS Speed:** The speed calculated by measuring the boat's change in geographical location over a given time using GPS data.

**i-Pilot Controller:** The i-Pilot controller is part of the i-Pilot system. The controller contains a GPS receiver, compass and electronics to automatically navigate the trolling motor. The controller resembles a motor control box

cover and is completely sealed and waterproof. The controller replaces the existing control box cover and **AutoPilot** controller if one is present.

**i-Pilot Controller Cable:** On PowerDrive V2 and Riptide SP versions of i-Pilot, a cable exists on the bottom side of the i-Pilot controller. This cable is designed to connect to the foot pedal input cable at the base of the motor for a waterproof connection.

**i-Pilot Controller Connector:** On the Terrova and Riptide ST versions of i-Pilot, a connector exists on the bottom side of the i-Pilot controller. This connector is designed to connect to the accessories connector for an easy waterproof connection.

**Motor Speed:** The speed that the prop is rotating from 0 to 10, which is adjustable in  $\frac{1}{2}$  increments.

**PowerDrive V2:** The PowerDrive V2 is in the latest family of bow-mount, electric-steer trolling motors from Minn Kota. The motor can be identified by the PowerDrive V2 name on the side of the trolling motor mount.

**Riptide SP:** The Riptide SP is in the latest family of saltwater bow-mount, electric-steer trolling motors from Minn Kota. The motor can be identified by the Riptide SP name on the side of the trolling motor mount.

**Riptide ST:** The Riptide ST is in the latest family of saltwater bow-mount, electric-steer trolling motors from Minn Kota. The motor can be identified by the Riptide ST name on the side of the trolling motor mount.

**Side Plates:** Side plates exist on each side of the trolling motor mount. These side plates cover and protect mechanical and electrical components from the environment. The side plates are temporarily removed from PowerDrive V2 and Riptide SP motors during i-Pilot installation.

**Terrova:** The Terrova is in the latest family of bow-mount, electric-steer trolling motors from Minn Kota. The motor can be identified by the Terrova name on the side of the trolling motor mount.

**Track End:** The last point on a recorded track, which is made when **Track Recording** was ended.

**Track Start:** The first point on a recorded track, which is made when the **Track Record** button is pressed to start a recording.

# COMPLIANCE STATEMENTS



## ENVIRONMENTAL COMPLIANCE STATEMENT:

It is the intention of Johnson Outdoors Inc. to be a responsible corporate citizen, operating in compliance with known and applicable environmental regulations and a good neighbor in the communities where we make or sell our products.

### WEEE Directive:

EU Directive 2002/96/EC “Waste of Electrical and Electronic Equipment Directive (WEEE)” impacts most distributors, sellers and manufacturers of consumer electronics in the European Union. The WEEE Directive requires the producer of consumer electronics to take responsibility for the management of waste from their products to achieve environmentally responsible disposal during the product life cycle. WEEE compliance may not be required in your location for electrical and electronic equipment (EEE), nor may it be required for EEE designed and intended as fixed or temporary installation in transportation vehicles such as automobiles, aircraft and boats. In some European Union member states, these vehicles are considered outside of the scope of the Directive, and EEE for those applications can be considered excluded from the WEEE Directive requirement. This symbol (WEEE wheeled bin) on product indicates the product must not be disposed of with other household refuse. It must be disposed of and collected for recycling and recovery of waste EEE. Johnson Outdoors Inc. will mark all EEE products in accordance with the WEEE Directive. It is our goal to comply in the collection, treatment, recovery and environmentally sound disposal of those products; however, these requirements do vary within European Union member states. For more information about where you should dispose of your waste equipment for recycling and recovery and/or your European Union member state requirements, please contact your dealer or distributor from which your product was purchased.

### FEATURES CAR ACTÉRISTIQUES

#### DÉCLARATION DE CONFORMITÉ ENVIRONNEMENTALE :

Johnson Outdoors Inc. a l'intention d'être une corporation responsable, fonctionnant en conformité avec les règlements environnementaux connus et applicables, et d'agir en tant que bon voisin dans les communautés où nous fabriquons ou vendons nos produits.

#### Directive WEEE :

La Directive 2002/96/EC de l'Union européenne traitant des déchets d'équipement électriques et électroniques, soit “Waste of Electrical and Electronic Equipment (WEEE)”, affecte la plupart des distributeurs, vendeurs et fabricants de produits électroniques dans l'Union européenne. La directive WEEE demande que le fabricant de produits électroniques se charge de la gestion des déchets provenant de leurs produits afin de s'en débarrasser d'une manière responsable par rapport à l'environnement au cours du cycle de vie du produit. Respecter la directive WEEE peut ne pas être exigé où vous vous trouvez en ce qui concerne l'équipement électrique et électronique (EEE), comme ne pas être exigé pour l'équipement électrique et électronique conçu et destiné à des installations temporaires ou permanentes dans les véhicules de transport comme les automobiles, avions et bateaux. Dans quelques pays membres de l'Union

européenne, ces véhicules sont considérés comme au-delà des limites de la directive et l'équipement électrique et électronique pour ces applications peut être considéré exclus des exigences de la directive WEEE. Ce symbole (roue WEEE) sur un produit indique que le produit ne doit pas être jeté parmi les déchets domestiques. Il doit être mis au rebut et ramassé pour le recyclage et la récupération de déchet d'équipement électrique et électronique. Johnson Outdoors Inc marquera tout équipement électrique et électronique selon la directive WEEE. Nous avons pour but de respecter le ramassage, le traitement, la récupération et la mise au rebut raisonnable par rapport à l'environnement de ces produits ; néanmoins, ces exigences varient parmi les pays membres de l'Union européenne. Pour plus de renseignements sur où mettre au rebut les déchets de votre équipement afin de les recycler ou les récupérer et/ou sur les exigences de votre pays membre de l'Union européenne, veuillez contacter le concessionnaire ou distributeur de qui vous avez acheté le produit.

**FCC ID:**

**Remote T62-IPREM**

**Controller T62-IPCON**

**Industry Canada ID:**

**Remote 4397A-IPREM**

**Controller 4397A-IPCON**

**FCC Compliance Statement**

This equipment has been tested and found to comply with the limits for a Class B digital device, pursuant to Part 15 of the FCC Rules. These limits are designed to provide reasonable protection against harmful interference in a residential installation. This equipment generates, uses, and can radiate radio frequency energy and, if not installed and used in accordance with the instructions, may cause harmful interference to radio communications. However, there is no guarantee that interference will not occur in a particular installation. If this equipment does cause harmful interference to radio or television reception, which can be determined by turning the equipment off and on, the user is encouraged to try to correct the interference by one or more of the following measures:

- Reorient or relocate the equipment.
- Increase the separation between the equipment and receiver.
- Consult the dealer or an experienced radio or television technician for help.

**IC Compliance Statement**

The term "IC" before the certification/registration numbers only signifies that the Industry Canada technical specifications were met.





## HALF THE CHARGE TIME AT HALF THE WEIGHT.

When batteries fail, most anglers blame overuse. But improper charging causes battery failure more than any other factor. Our all-new high-frequency, digital microprocessor design is more compact, up to 50% lighter, and engineered to extend battery life and deliver up to 50% faster charging time. You invest a lot in your batteries: time, money and the opportunity to catch more fish. Protect that investment with our all-new line of Precision Chargers.



NEW  
MK 110PC



NEW  
MK 220PC



NEW  
MK 330PC

NEW  
MK 440PC  
NOT SHOWN

## NEW PRECISION CHARGE ON-BOARD CHARGERS.

All Minn Kota Precision Chargers feature:

- High-frequency, digital microprocessor design charges up to 50% faster than other chargers
- Low-line voltage compensation, automatic temperature compensation and multi-stage charging to deliver the perfect charge
- On demand battery equalization to prevent sulfation build up on plates and extend battery life

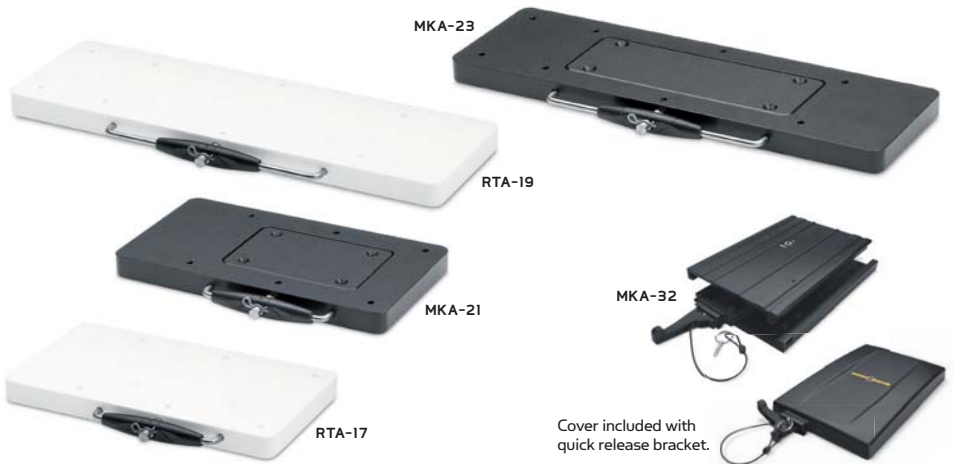

## COMPOSITE QUICK RELEASE BRACKETS (MKA-21, RTA-17, RTA-19)

Allows for easy removal of any Terrova, PowerDrive V2, PowerDrive or Pontoon HC (MKA-21); Maxxum, Maxxum Pro, All Terrain or Edge (MKA-23); Riptide ST or Riptide SP (RTA-17); or Riptide SM or Riptide SE (RTA-19) bow-mount motor. High-yield composite construction is super strong and impervious to corrosion. Low-profile design leaves deck clear when motor is removed. Locking handle with stainless steel pins can be secured with padlock (not included).

## ELECTRIC STEER QUICK RELEASE BRACKET WITH COVER (MKA-32)

Designed for fast removal of any Terrova, PowerDrive V2 or PowerDrive bow-mount trolling motor. New cam-lock design features ultra-tight tolerances that eliminate bracket movement and noise. Locking lever includes pin and lanyard. Upper and lower plates include slot for securing with padlock (not included). Includes composite cover that attaches to lower half of bracket when motor is removed, keeping the deck profile clean.







[minnkotamotors.com](http://minnkotamotors.com)

**MINN KOTA CONSUMER  
& TECHNICAL SERVICE**

P.O. Box 8129  
Mankato, MN 56002

121 Power Drive  
Mankato, MN 56001  
Phone (800) 227-6433  
Fax (800) 527-4464

